

PASSIVE INFRARED DETECTOR

RX CORE series
RXC-ST

Grade 2
EN50131-2-2

DIGITAL QUAD ZONE LOGIC

Built on OPTEx's proven RX and CX series technology, RXC-ST provides higher performance in higher temperatures, features digital target recognition and is suitable for Grade 2 residential, commercial or industrial applications.



QUAD ZONE LOGIC

Digital target recognition for small animal tolerance

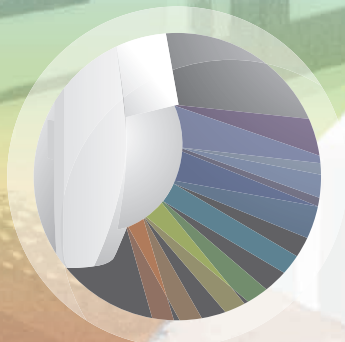

HIGH DENSITY PATTERN

To enhance catch performance

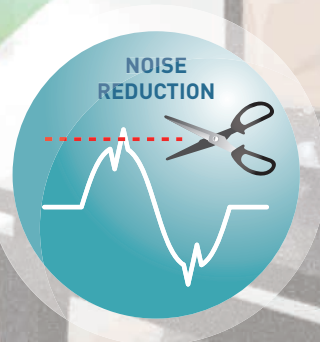

NOISE REDUCTION

Improved RF and white light immunity

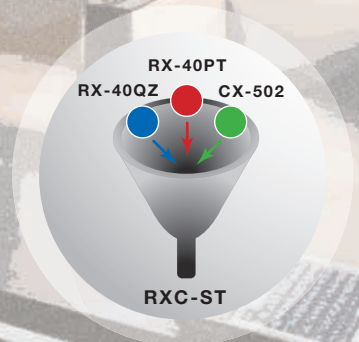

PROVEN TECHNOLOGY

Built on three iconic detectors' technology

PASSIVE INFRARED DETECTOR

RX CORE Series

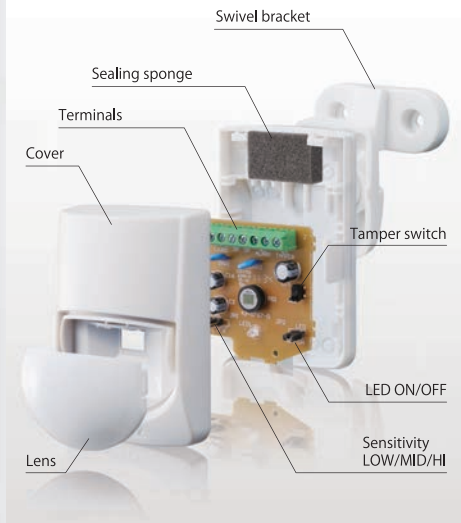

DIGITAL QUAD ZONE LOGIC

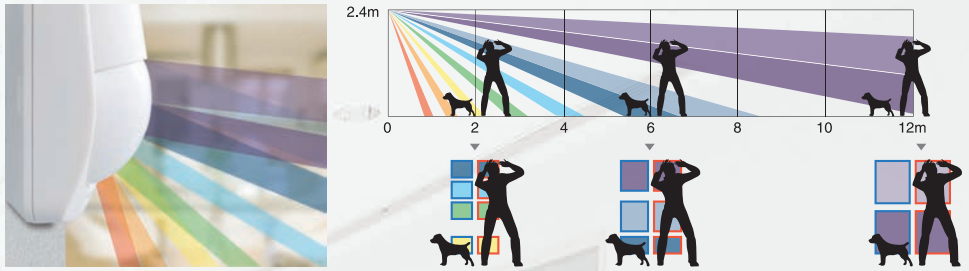

RX CORE has 78 dense zones to cover the whole coverage. At any spot within the coverage more than 4 (quad) zones are utilized to verify if it should generate alarm or not. Also The CORE Platform enabled the QUAD ZONE LOGIC to evolve to the next step. Providing digital quantification of infrared energy, RX-CORE enhanced accuracy in both human detectability and pet immunity.

SILENT OUTPUT



The original micro-processor technology enabled ECO PLATFORM operate under complete silence. There is no mechanical relay component that disturb the environment with clicking noise and making RX-CORE invisible in daily scenes.

MULTI ANGLE BRACKET

Ceiling and wall mounting are available. Horizontally ± 45 degree, Vertically 0 to 15 degree downwards.



Ceiling mount

Wall mount

BASIC PERFORMANCE

ADVANCED SEALED OPTICS



ADVANCED TEMPERATURE COMPENSATION LOGIC

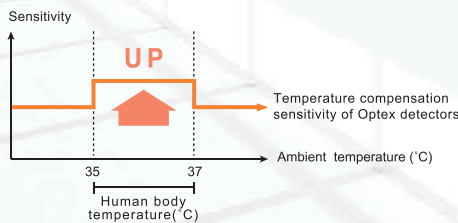

It automatically increases the detector's sensitivity under high temperature conditions, especially where the background temperature ranges from 35-37°C (63 - 67°F), close to that of the human body.

OPTION

18m long range lens : FL-60N

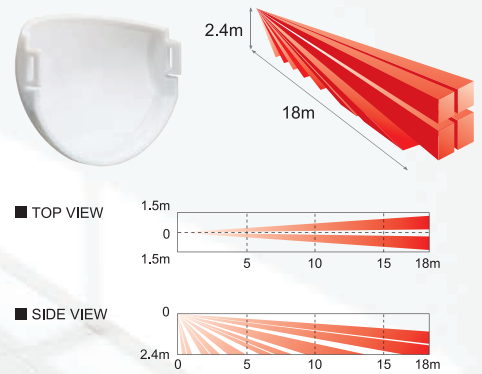

COVERAGE

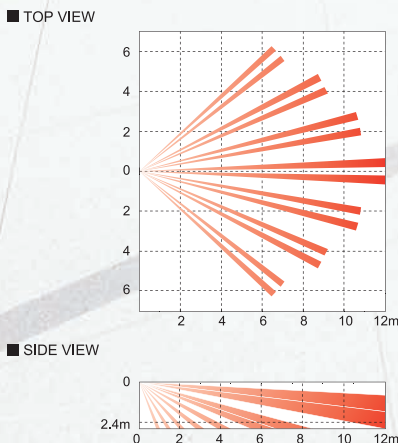

SPECIFICATIONS

| Model | RXC-ST |
|------------------------|-----------------------------------|
| Detection method | Passive infrared |
| Coverage | 12m x 12m(40ft x 40ft) 85°wide |
| Detection zones | 78 zones |
| Mounting height | 1.5 to 2.4m (5 to 8ft) |
| LED alarm indicator | Switchable ON/OFF |
| Alarm period | Approx. 2.5 sec |
| Alarm output | N.C., 24VDC 0.2A max. |
| Tamper switch | N.C., Open when cover is removed. |
| Sensitivity/range | Switchable LOW/MID/Hi |
| Warm up period | Approx. 30 sec |
| Power input | 9.5 to 16VDC |
| Current draw | 8mA(normal), 11mA(max.) at 12VDC |
| Dimensions | 93.4mm x 61.4mm x 46.0mm <HxWxD> |
| Weight | Approx. 70g (with bracket: 90g) |
| Operating temperature | -20°C to +50°C(-4°F to +122°F) |
| Environmental humidity | 95% max. |
| RF interference | No alarm 10V/m |

DIMENSIONS

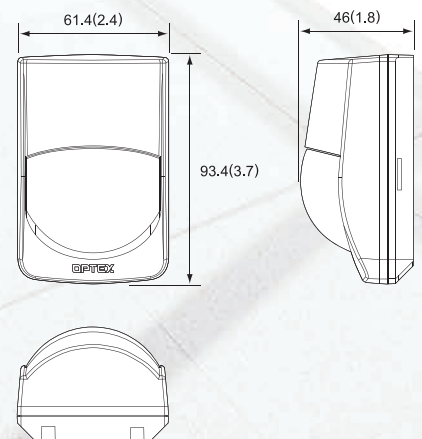

※Specifications are subject to change without prior notice.

Unit:mm(inch)



OPTEX CO., LTD. (ISO 9001 Certified / ISO14001 Certified)

5-8-12 Ogoto, Otsu, Shiga, 520-0101 Japan

TEL +81(0)77 579 8670 FAX +81(0)77 579 8190

<http://www.optex.co.jp/e/>

OPTEX INCORPORATED (USA)

<http://www.optexamerica.com/>

OPTEX (EUROPE) LTD. (UK)

<http://www.optex-europe.com/>
(ISO9001 Certified)

OPTEX SECURITY SAS (FRANCE)

<http://www.optex-security.com/>

OPTEX KOREA CO., LTD. (KOREA)

<http://www.optexkorea.com/>

OPTEX SECURITY Sp. z o.o. (POLAND)

<http://www.optex.com.pl/>

OPTEX (DONGGUAN) CO., LTD.

<http://www.optexchina.com/>

SHANGHAI OFFICE (CHINA)