

Multidoor



Access control system

simple . flexible . secure



AR716-E18
Multidoor Controller

SOYAL multidoor controller. Advanced & more extensive control of who (card user), which door (door group), when (time zone) using what method (card and/or pin) High capacity 15,000 user of GLOBAL anti-passback across all online readers.

Central Monitoring & Controlling

Provide more efficient data collection & monitoring of each reader. Can use online reader to manually control other electrical equipments. Alarm notification if reader is offline, force entry or anti-passback error

Global anti-passback

Centralized door lock control for each reader to achieve tamper proof security. Supported schedule auto reset of any-passback.

Flexible Time Zone & Access Mode

Door auto unlock following pre-set time zone schedule. Support different access mode within the same day for tighter security. Ex. Morning is card only, Night is card & pin and no access after midnight.

Easy to use Software

Software has clean GUI and optimized to provide practical function instead of crowded with unnecessary features. This make our software easier to learn, simpler to use and easier to be assist by technical support. Our software is simpler enough for small company and yet powerful enough to cater the needs of big organization.

Emergency Release

Emergency all door open or part of the access platform through software or push button.

Expiry date function

Each user access authority effective date can be configured in software. This allow management manage accessibility of user more effective.

Automation Function

4 programmable input & 4 weekly schduled output for automation function. Support 1/) expander for additional 8 input & 8 output

AR727i
TCPIP Network Module

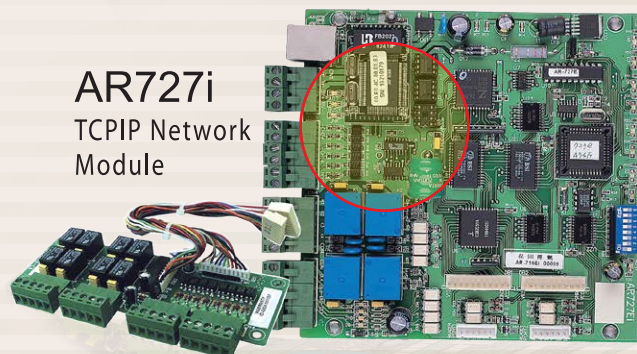

AR716EIO
Expander Relay Board

Icon based menu easy to learn

E-map pin point threat location and helps you response to alert faster

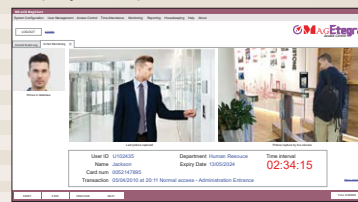

Clean and easy interface

Time attendance multi shift

Date	Time	Dir Code	Card Code	Door	Event	User ID	Stems	Department	Designated
08/12/2018	21:05	00019	00000	1.0	Normal access by card only	JA00000	Production	Marketing	Designated
08/12/2018	21:05	00019	00000	1.0	Normal access by card only	JA00000	Production	Marketing	Designated
08/12/2018	21:05	00019	00000	1.0	Normal access by card only	JA00000	Production	Marketing	Designated
08/12/2018	21:05	00019	00000	1.0	Normal access by card only	JA00000	Production	Marketing	Designated
08/12/2018	21:05	00019	00000	1.0	Normal access by card only	JA00000	Production	Marketing	Designated
08/12/2018	21:05	00019	00000	1.0	Normal access by card only	JA00000	Production	Marketing	Designated
08/12/2018	21:05	00019	00000	1.0	Normal access by card only	JA00000	Production	Marketing	Designated
08/12/2018	21:05	00019	00000	1.0	Normal access by card only	JA00000	Production	Marketing	Designated
08/12/2018	21:05	00019	00000	1.0	Normal access by card only	JA00000	Production	Marketing	Designated
08/12/2018	21:05	00019	00000	1.0	Normal access by card only	JA00000	Production	Marketing	Designated

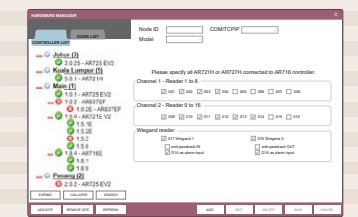

MAG Etegra

Integrated Access Security Software

- Lite - Standalone function
- Pro Basic - Client/server network and CCTV
- Pro Advance - More extensive network and CCTV

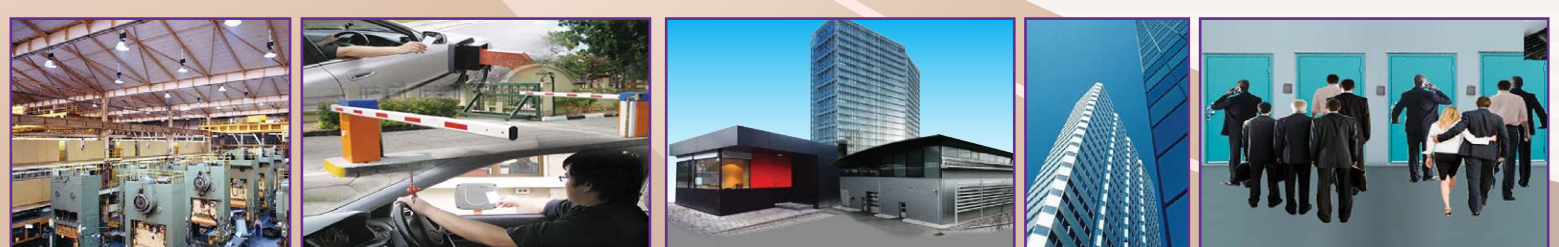

Multidoor RFID access control system



AR716-E18 is a multi door controller. It can support up to 16 online reader in combination of AR721H, AR727H, AR721U, AR737U, AR737H, AR661U. AR716E offer more precise access control that can cater to large capacity and more demanding requirement.

AR716-E18 specification

Card user	15000
Event memory	11000
Time zone	63
Holiday per year	120
Door group	255
Anti-passback	Global anti-passback among 16 readers
Node address setting	On board DIP switch
Automation function	Programmable 4 input and 4 output
Duress function	4 set of duress pin number
DirectPC software support	YES
Programming method	Program new user and operation parameters through software.
Max reader supported	16 readers
External Wiegand port for anti-passback function	2 port for in and out
User expiry date setting	Full range for 15000 users for ending expiry date only.

RS485 network connection

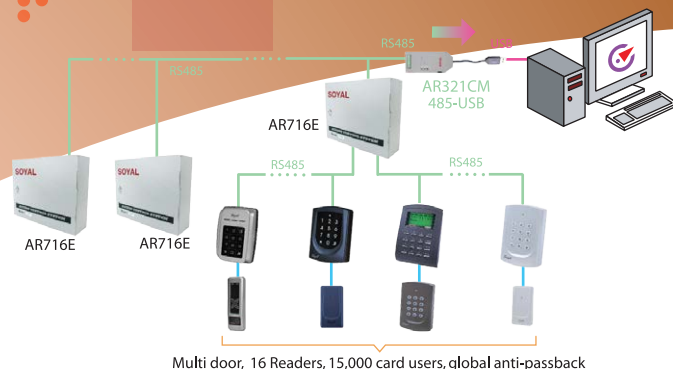

TCP/IP network connection

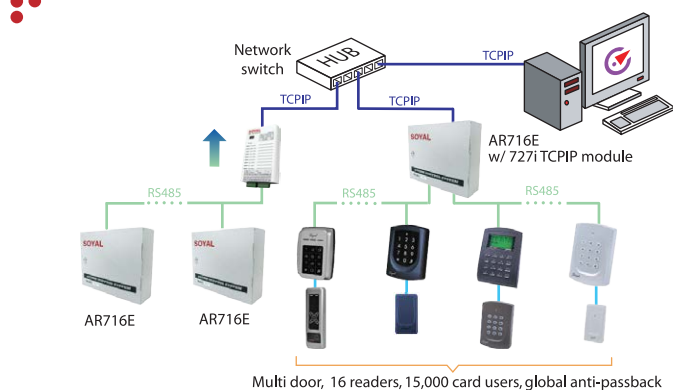

AR716-E18 Parameter

Door unlock time interval	Pre-set time 0.1 to 600 sec
Alarm relay output (Buzzer)	12V / 2A N.O. / N.C. (set by jumper) COM common 0-600 sec
Serial port	RS485, 9600bps (N,8,1)
Power consumption	15-24VDC. Less than 2.5W
Dimension (mm)	128 (L) x 96 (W) x 41 (H)
Weight	240 g

AR 727i Parameter

Interface	10/100M Base T Ethernet UART (TTL)
Baud Rate	4800bps - 115200bps

Accessories



716E-18 connection

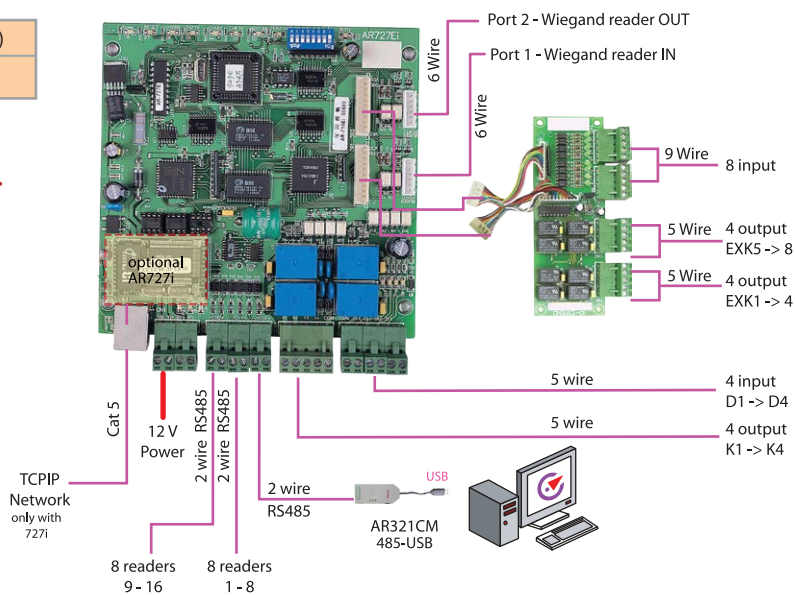

Authorized dealer

SOYAL®

Features, specifications and dimensions are subject to change without notice.

WWW.SOYAL.COM.MY